

Canna Quadrata

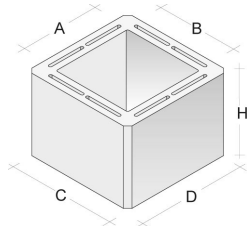

Articolo	Dimensioni interne cm		Dimensioni esterne cm			Peso kg/pz	Pezzi ml	Pacco q.li	Pacco ml
Canna 15	A 15	B 15	C 25	D 25	H 25	13	4	15	28
Canna 20	A 20	B 20	C 30	D 30	H 25	17	4	14,5	21
Canna 25	A 25	B 25	C 35	D 35	H 25	19	4	12	15,75
Canna 20/30	A 20	B 30	C 30	D 40	H 25	18	4	10,5	14
Canna 30	A 30	B 30	C 40	D 40	H 25	22	4	9,5	10,5
Canna 40	A 40	B 40	C 50	D 50	H 25	35	4	10	7

Canna Circolare

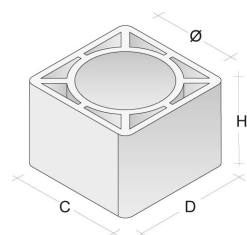

Articolo	Diametro interno cm	Dimensioni esterne cm			Peso kg/pz	Pezzi ml	Pacco q.li	Pacco ml
Cannacirc 15	Ø 15	C 25	D 25	H 25	10	4	11	28
Cannacirc 22	Ø 22	C 30	D 30	H 25	15	4	12,5	21
Cannacirc 27	Ø 27	C 35	D 35	H 25	17	4	11	15,75
Cannacirc 32	Ø 32	C 40	D 40	H 25	21	4	9	10,5

CANNE FUMARIE COLLETTIVE

EUROCANNAGAS QUADRATA (CE UNI EN 1858) - PER CALDAIE A CAMERA STAGNA

Eurocannagas Quadrata

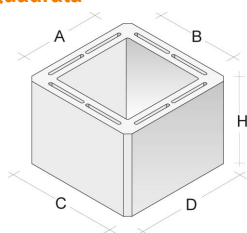

Articolo	Dimensioni interne cm		Dimensioni esterne cm			Peso kg/pz	Pezzi m	Pacco q.li	Pacco m
Euro 15	A 15	B 15	C 25	D 25	H 25	10	4	11	28
Euro 20	A 20	B 20	C 30	D 30	H 25	13	4	11	21
Euro 25	A 25	B 25	C 35	D 35	H 25	14	4	9	15,75
Euro 30	A 30	B 30	C 40	D 40	H 25	16	4	6,5	10,5

ACCESSORI E PEZZI SPECIALI PER EUROCANNAGAS QUADRATA

Camera di ispezione

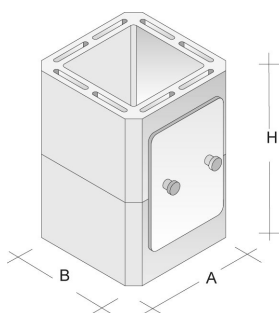

Camera di ispezione con sportellino metallico a tenuta d'aria per canne fumarie collettive.

Dimensioni interne cm		Dimensioni esterne cm			Peso kg/pz
A 20	B 20	A 30	B 30	H 50	35
A 25	B 25	A 35	B 35	H 50	35
A 30	B 30	A 40	B 40	H 50	35

Apertura di compensazione

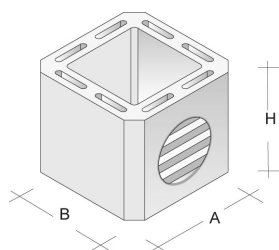

Elemento con apertura di compensazione completo di griglia per canne fumarie collettive.

Dimensioni interne cm		Dimensioni esterne cm			Peso kg/pz
A 15	B 15	A 25	B 25	H 25	11
A 20	B 20	A 30	B 30	H 25	11
A 25	B 25	A 35	B 35	H 25	11
A 30	B 30	A 40	B 40	H 25	11

**Eurocanna
Gas 25x46**

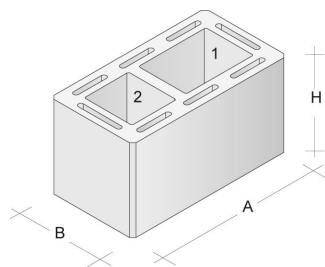

Dimensioni Condotti cm		Dimensioni esterne cm			Peso kg/pz	Pacco q.li	Pacco ml
1: 20,5 x15	2: 13,5 x15	A 47	B 25	H 25	17	10	14

ACCESSORI E PEZZI SPECIALI PER CANNE EUROCANNAGAS 25x46

**Deviatore per Canna
Gas 25x46**

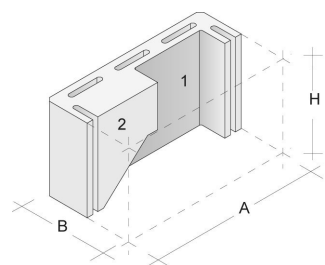

Dimensioni Condotti cm		Dimensioni esterne cm			Peso kg/pz	Pacco q.li	Pacco Pz
1: 20,5 x15	2: Deviazione 45°	A 47	B 25	H 25	20	11,2	56

**Comignolo per Canna
Gas 25x46**

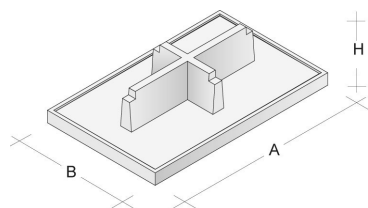

Dimensioni Condotti cm		Dimensioni esterne cm			Peso kg/pz	Pacco q.li	Pacco Pz
-	-	A 56	B 35	H 13	17	-	-

**Camera di Ispezione
Canna Gas**

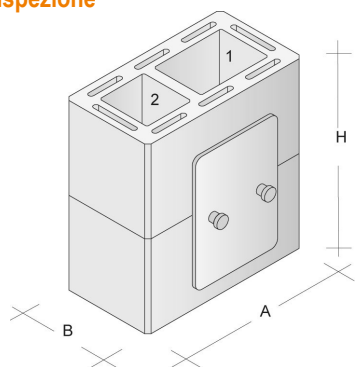

Camera di ispezione con sportellino metallico a tenuta d'aria per canne fumarie collettive ramificate.

Dimensioni Condotti cm		Dimensioni esterne cm		
1 20,5 x 15	2 13,5 x 15	A 47	B 25	H 50

COMIGNOLI COMPLETI ASPIRANTI-ANTIVENTO PER CANNE FUMARIE

Comignoli per canne fumarie

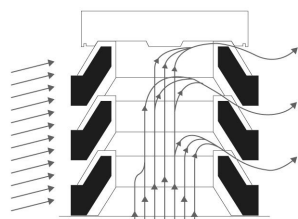
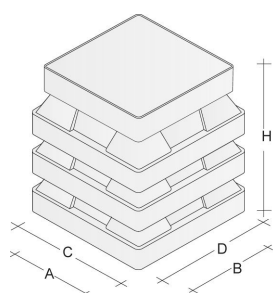

Articolo	Dim. interne cm		Dimensioni esterne cm			Peso kg/pz	Pacco q.li	Pacco pz
Ch 15	A 15	B 15	C 33,5	D 33,5	H 35	44	12	27
Ch 20	A 20	B 20	C 40,5	D 40,5	H 36	65	11,5	18
Ch 25	A 25	B 25	C 46,5	D 46,5	H 39	79	9,5	12
Ch 20/30	A 20	B 30	C 38,0	D 48,0	H 42	49	9	18
Ch 30	A 30	B 30	C 51,5	D 51,5	H 38	101	12	12
Ch 40	A 40	B 40	C 58,0	D 58,0	H 42	100	8	8

Comignoli composti da 4 elementi: 3 Anelli + 1 Cappello